

Diesel Generator Set:GB-20

Standard Features	
MODEL	GB-20
Standby Power(50Hz)	17.6KW/22KVA
Prime Power(50Hz)	16KW/20KVA
Engine	GB-485A
Alternator	GB-184ES

- Standard control panel, Including controller, Operation lighting, Emergency stop button, Buzzer
- Main line circuit breaker
- One 12V free maintenance battery, battery charger, Battery Ract and Battery Switch
- Industrial silencer, Ripple Flex exhaust pipe, Flange
- Fork lift position and lifting position
- With-8 hours Base Fuel Tank; Fuel Tank Capacity: 100L
- Radiator 50°C max, Fans driven by Belt, with safety Guard
- Hand pump special for take out dirty oil



Open Type

Silent Type

Generator Set Ratings						
Voltage	Frequency	Phase	P.F (COS ϕ)	Prime Current Amps	Standby Power (KW/KVA)	Prime Power (KW/KVA)
440/254	50	3	0.8	26	17.6/22	16/20
415/240	50	3	0.8	28	17.6/22	16/20
400/230	50	3	0.8	29	17.6/22	16/20
380/220	50	3	0.8	30	17.6/22	16/20

Prime Power(PRP):Prime power is available for an unlimited number of annual hours in variable load application, in accordance with GB/T2820-97(eqvISO8528);10% overload capability is available for a period of 1 hour within a 12-hour period of operation. Standby Power Rating (STP):The standby power rating is applicable for supplying emergency

Dimension & Weight Of Generator Set	
Dimension(L*W*H)/CM For Open Type	150×76×120 CM
Net Weight/KG For Open Type	450KGS
Dimension(L*W*H)/CM For Silent Type	202×92×110 CM
Net Weight/KG For Silent Type	890KGS
Dimension (L*W*H)/MM For Trailer Type	
Net Weight/KG For Trailer Type	

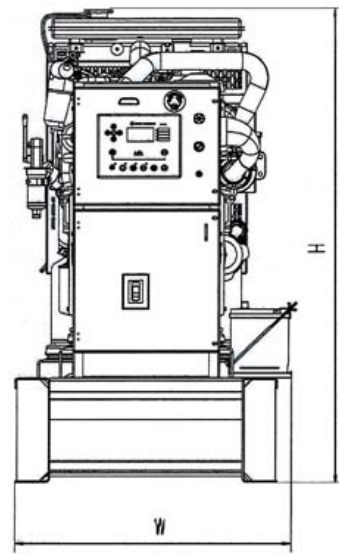
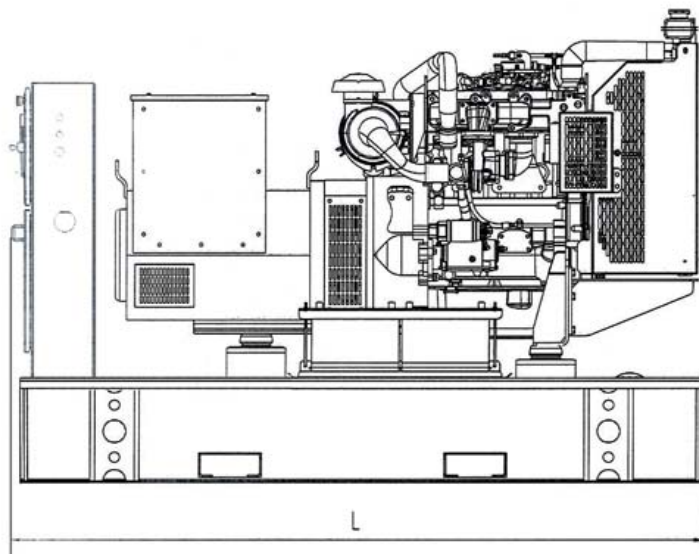
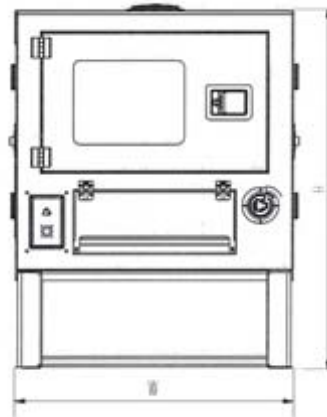
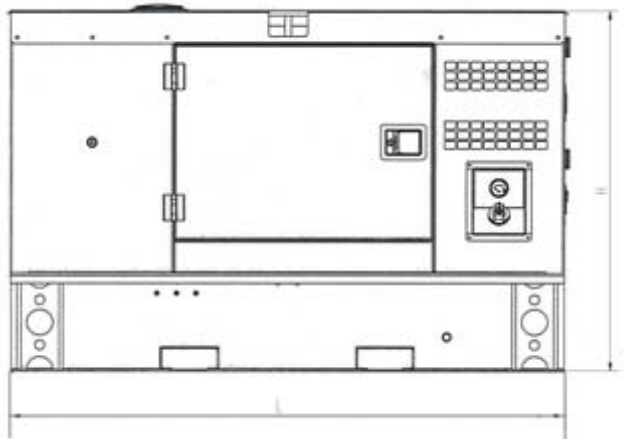
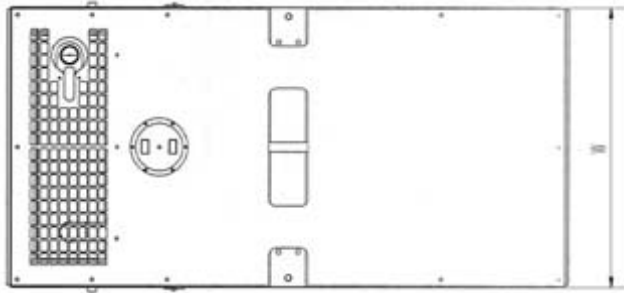

Specification of Engine		
Basic Specification	Engine Model	GB-485A
	Manufacturer	GB Company
	Prime Power	17KW
	Standby Power	18.7KW
	Engine Configuration	4Cylinder In Line, 4Stroke, Direct Injection
	Gas Feeding Model	Natural Aspiration
	Bore × Stroke	84×100(MM)
	Displacement	2.216L
	Rated Speed	1500RPM
	Speed Governor	Mechanical
	Starter Model	12V DC Start
	Cooling System	Water Cool
	Compression Ratio	23.3:1
Exhaust System	Exhaust Gas Flow	4.76m ³ /min
	Exhaust Temperature	510℃
	Max Back Pressure	10.2kPa
Air Intake System	Max Intake Restriction	6.4kPa
	Burning Capacity	1.74m ³ /min
	Air Flow	40.2m ³ /min
Fuel System	Fuel Consumption (Prime Power 100%) Load	5.3L/H
	Fuel Consumption (Prime Power 75%) Load	4.0L/H
	Fuel Tank Capacity	5.4L/h
Lubrication System	Oil Capacity	10.6L
	Oil Consumption	≤0.15% of Fuel Consumption
	Oil Pressure at Rated RPM	352-448kPa
Cooling System	Total Coolant Capacity	7L
	Thermostat Open Temperature	82-95℃
	Max Coolant Temperature	112℃

Specification of Alternator



Basic Specification	Alternator Model	GB-184ES
	Manufacturer	GB company
	Prime Output	16KW/20KVA
	Standby Output	17.6KW/22KVA
	Excitation Model	Brushless, Self-Exciting
	Cooling Method	Air Cooling
	Connection Type	3 Phase and 12 Wires "Star" Connection
	Power Factor	0.8
	Protection Class	IP23
	Insulation Class	H
	Altitude	≤ 1000m
	Voltage Regulation, Steady State	≤ ± 1%
	Telephone Influence Factor	< 50
	Sudden Voltage Warp (100% Sudden Reduce)	≤ ± 1%
	Sudden Voltage Warp (Sudden Increase)	≤ ± 25%
	Voltage Stable Time (100% Sudden Reduce)	≤ 6S
	Voltage Stable Time (Sudden Increase)	≤ 6S
	Frequency Reduce	0-5% adjustable
	Frequency Regulation, Stead State	≤ 1.5%
	Frequency Waving	≤ 0.8%
	Sudden Frequency Warp (100% Sudden Reduce)	≤ +12%
	Sudden Frequency Warp (100% Sudden Increase)	≤ -10%
	Frequency Recovery Time (100% Sudden Reduce)	≤ 5S
	Frequency Recovery Time (Sudden Increase)	≤ 5S
Compliance GB755,BS5000,VDE0530,NEMAMG1-22,IED34-1,CSA22.2 and AS1359 Stands		

Control Panel System

1.SINGLE SET GEN-SET CONTROLLER

SUM : They meet all possible requirements for AMF applications,including modem control,user configuration and full gen-set monitoring and protection. AMF models enable the combination of manual and remote start application with auto mains fail function.

KEY FEATURES:

1. High water Temperature Shutdown	
2. Low Oil Pressure Shutdown	
3. Over Speed Shutdown	
4. Over Crank Shutdown	
5. Function as Emergent Stop	
6. Heated Display Option	
7. Breaker Control Buttons on Front Fascia	
8. Alternative Configuration (50Hz/60Hz)	
9.Support ATS Function	
KEY FEATURES:	
1. High Water Temperature Shutdown	
2. Low Oil Pressure Shutdown	
3. Over Speed Shutdown	
4. Over Crank Shutdown	
5. Function as Emergent Stop	
6. With Remote Teleport Communication RS 485	
7. Heated Display Option.	
8. Alternative Configuration (50HZ/60HZ)	
9. Support ATS Function	
10. Remote Communications (RS232 & RS485)	
11. Fuel Usage Monitor And Low Level Alarms.	
12. Engine Specific J1939 for All Major Manufacturers	
13. Configurable Display Languages.	
14. Load Switching, Load Shedding&Dummy Load Outputs.	
15. Alternative Configuration (50Hz/60Hz)	

a.DSE 6020KII

b.ComAp AMF 20





c.DSE 7320

d.ComAp AMF 25

2. MULTIPLE PARALLELING GEN-SETS WITH INTERNAL LOAD-SHARING CONTROLLER

SUM: Functionality, optimized for ease of use, installation and configuration, includes built-in synchronization and digital isochronous active and reactive load sharer. Native co-operation of up to 32 gen-sets is a standard feature.

KEY FEATURES:

1. The Most up to 32-set Synchronization	
2. Wide Range of Communication Interfaces - RS232, RS485, USB, Modbus, GSM/Analog Modem, GPRS, Ethernet	
3. Direct Governor & AVR Control	
4. kW & kV Ar Load Sharing	
5. Advanced Power Management Function	
Load Dependent Start/Stop	
Load Demand Swap	
Running Hours Equalization	
6. Support of Electronic Controlled Engines (J1939, Modbus)	



a.DSE 8610

b.ComAp IC-NT NINT

3. SINGLE GEN-SET IN PARALLEL TO MAINS CONTROLLER

SUM: They are integrated controllers combining AMF and paralleling functions for single gen-sets. This combination allows the gen-set with interrupt-free transfers as well as in continuous parallel-to -mains mode.

KEY FEATURES:

1. Mains (Utility) Failure Detection, Mains (Utility) Power Monitoring (kW, kV Ar, kV A & pf) Monitoring, Mains (Utility) Decoupling Protection, Mains (utility) kW Export Protection.	
2. Remote Communications (RS232, RS485 x2, Ethernet)	
3. High Tariff Avoidance, Peak Shaving, Peak Lopping	
4. Synchronization of MCB (Reverse Synchronization)	
5. Support of Electronic Controlled Engines (J1939, Modbus)	
6. Wide Range of Communication Interfaces - RS232, RS485, USB, Modbus, GSM/Analog Modem, GPRS,	

a.DSE 8620

b.ComAp IC-NT SPTM

Ethernet			
Generator Set Options and Accessories			
Generator Set Design		Control System	
Open Type	<input type="checkbox"/>	AMF(Automatic Management Function)	<input type="checkbox"/>
Silent Type	<input type="checkbox"/>	ATS(Automatic Transfer System)	<input type="checkbox"/>
Super Silent Type	<input type="checkbox"/>	ASS(Automatics Synchronization System)	<input type="checkbox"/>
Trailer Type	<input type="checkbox"/>	Remote Control Puma	<input type="checkbox"/>
Fuel System		Alternator	
12 Hour Base Tank(single wall)	<input type="checkbox"/>	PMG(EBS) Excitation	<input type="checkbox"/>
24 Hour Base Tank(single wall)	<input type="checkbox"/>	Space Heater	<input type="checkbox"/>
Dual Wall Base Fuel Tank	<input type="checkbox"/>	Preheater System	
Outside Fuel Tank	<input type="checkbox"/>	Coolant Preheater	<input type="checkbox"/>
Automatic Refueling Compensation System	<input type="checkbox"/>	Oil Preheater	<input type="checkbox"/>
Exhaust System		Battery Preheater	<input type="checkbox"/>
Residential Exhaust Silencer	<input type="checkbox"/>		
Circuit Breaker Brand			
CHNT	<input type="checkbox"/>		
ABB	<input type="checkbox"/>		